

GB 塑料滚动轴承
GB Plastic Rolling Bearings



GB塑料滚动轴承
GB Plastic Rolling Bearings

GB 塑料滚动轴承 GB Plastic Rolling Bearings



产品特性 Product Features

GB 系列塑料滚动轴承内外圈以及保持架均采用优质工程塑料制成，滚珠材料为不锈钢（选配）、玻璃、陶瓷等，GB 系列塑料滚动轴承具有良好的自润滑性能和耐磨蚀性能突出的是比 EP 系列塑料滚动轴承具有极其高的运行速度，GB 系列轴承弥补了 EP 系列轴承不能在高速运动使用的场合。

GB series plastic rolling bearing is made of high quality engineering plastic. The balls are Stainless steel, Glass, Ceramics materias. This series of bearing are with perfect self-lubricating feature and anti-corrosion feature. Comparing with the normal EP series plastic bushings, the GB series plastic rolling bearing are suitable to be applied under high speed and therefore meet the high speed application that normal EP is not workable.

GB10 非金属滚动轴承 Nonmetallic Rolling Bearings



GB10 作为通用性最强的塑料滚动轴承具有良好的强度和耐磨性，由于其材料自身的润滑性噪音较低；此类轴承碱性环境下表现良好但不适合在酸性环境下长期运行。标准配置内外圈材料为：改良 POM，保持架材料为：改良 PA，滚珠材料为：玻璃球或不锈钢（选配）；长期连续使用温度 $-40\sim+80^{\circ}\text{C}$ 。

GB10 has good strength and wear resistance as a generic plastic rolling bearing, the operation noise very low because the self-lubrication of the material; these bearings perform well in an alkaline environment but not for long-term operation in an acidic environment. The standard material of inner and outer ring: POM, cage material: PA, ball material: glass or stainless steel; The long-term operation temperature: $-40\sim+80^{\circ}\text{C}$.

GB20 非金属滚动轴承 Nonmetallic Rolling Bearings



GB20 塑料滚动轴承具有低摩擦以及低温应用特性；此类轴承适合在酸碱交替环境下长期运行。标准配置内外圈材料为：改良 UPE，保持架材料为：改良 UPE，滚珠材料为：玻璃球或不锈钢（选配）；长期连续使用温度 $-150\sim+120^{\circ}\text{C}$ 。

GB20 series of plastic rolling bearing with low working temperature properties; these bearings are suitable for long-term operation in the acid-base alternate environment. The standard material of inner and outer ring: UPE, cage material: UPE, ball material: glass or stainless steel; The long-term operation temperature: $-100\sim+150^{\circ}\text{C}$.

GB 塑料滚动轴承 GB Plastic Rolling Bearings

GB30 非金属滚动轴承 Nonmetallic Rolling Bearings



GB30 系列塑料滚动轴承具有耐高低温、高承载以及最好的抗腐蚀性能；可应用在强酸、强碱、无机、有机盐、海水等领域。标准配置内外圈材料为：陶瓷；保持架材料为：改良 PTFE 或改良 PEEK；滚珠材料：陶瓷；长期连续使用温度 -200~+250℃。

GB30 series of plastic rolling bearing can work under very high temperature and low temperature. These bearings with high load and the best corrosion resistance; these bearings are good working under acid, alkaline, organic and inorganic salt as in sea water environments; The standard material of inner and outer ring: Ceramics, cage material: PTFE or PEEK, ball material: Ceramics; The long-term operation temperature: -200~+250℃.

GB40 非金属滚动轴承 Nonmetallic Rolling Bearings



GB40 系列塑料滚动轴承具有极好的机械强度和耐磨性能，此产品能在 150 度的高温下正常使用，并具有极好的抗腐蚀性能几乎在所有的腐蚀环境下运行；标准配置内外圈材料为：改良 PEEK；保持架材料为：改良 PEEK，滚珠材料为：陶瓷；长期连续使用温度 -100~+150℃。

GB40 series of plastic rolling bearing has excellent mechanical strength and wear resistance, Max. operation temperature 150℃, these bearings has excellent corrosion resistance to almost all corrosive environment; The standard material of inner and outer ring: PEEK, cage material: PEEK, ball material: Ceramics; The long-term operation temperature: -100~+150℃.

GB50 陶瓷滚动轴承 Ceramic Rolling Bearings



GB50 系列塑料滚动轴承具有耐高低温、高承载以及最好的抗腐蚀性性能；可应用在强酸、强碱、无机、有机盐、海水等领域。标准配置内外圈材料为：陶瓷；保持架材料为：改良 PTFE 或改良 PEEK；滚珠材料：陶瓷；长期连续使用温度 -200~+250℃。

GB50 series of plastic rolling bearing can work under very high temperature and low temperature. These bearings with high load and the best corrosion resistance; these bearings are good working under acid, alkaline, organic and inorganic salt as in sea water environments; The standard material of inner and outer ring: Ceramics, cage material: PTFE or PEEK, ball material: Ceramics; The long-term operation temperature: -200~+250℃.

GB 系列滚动轴承尺寸规格表

GB Series Rolling Bearings Dimensions Table

GB10 非金属滚动轴承 Nonmetallic Rolling Bearings

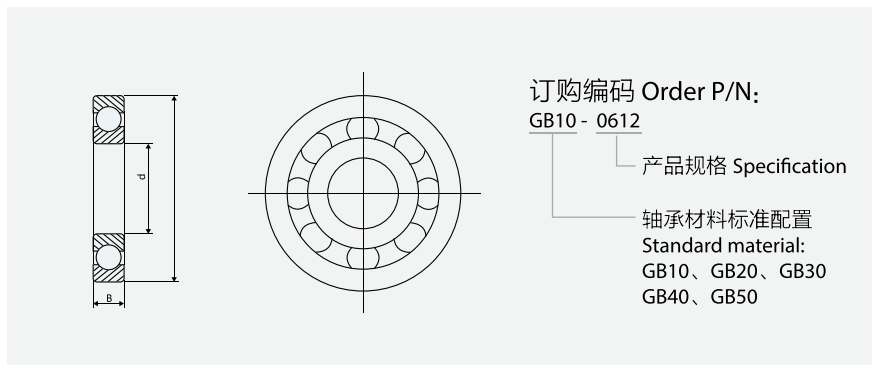

订购编码 Order P/N	d mm ²	D mm ²	B mm ²	极限静载荷 Max.static load N	极限动载荷 Max.dynamic load N	极限转速 Max.speed RPM
GB10-623	3	10	4	25	40	4050
GB10-624	4	13	5	35	50	3240
GB10-625	5	16	5	40	55	2745
GB10-626	6	-	6	40	60	2340
GB10-607	7	19	6	35	50	2340
GB10-627	7	22	7	45	65	1980
GB10-608	8	22	7	45	65	1980
GB10-609	9	24	7	50	75	1845
GB10-629	9	26	8	60	85	1710
GB10-6000	10	26	8	75	110	1710
GB10-6200	10	30	9	110	140	1485
GB10-6300	10	35	11	160	235	1260
GB10-6001	12	28	8	90	135	1575
GB10-6201	12	32	10	125	180	1395
GB10-6301	12	37	12	175	260	1170
GB10-6002	15	32	9	110	160	1395
GB10-6202	15	35	11	140	210	1260
GB10-6302	15	42	13	215	310	1080
GB10-16002	15	32	8	110	160	1350
GB10-6003	17	35	10	140	200	1260
GB10-6203	17	40	12	180	265	1125
GB10-6303	17	47	14	250	375	945
GB10-16003	17	35	8	135	200	1260
GB10-6004	20	42	12	165	250	1080
GB10-6204	20	47	14	225	350	945
GB10-6304	20	52	15	290	440	855
GB10-16004	20	42	8	160	240	1035
GB10-6005	25	47	12	200	300	945
GB10-6205	25	52	15	265	400	855
GB10-6305	25	62	17	330	500	655
GB10-16005	25	47	8	175	260	945
GB10-6006	30	55	13	235	350	810
GB10-6206	30	62	16	300	450	720
GB10-6306	30	72	19	380	580	610
GB10-16006	30	55	9	200	310	810
GB10-6007	35	62	14	265	400	720
GB10-6207	35	72	17	340	515	630
GB10-6307	35	80	21	405	625	540
GB10-16007	35	62	9	240	350	720

GB 系列滚动轴承尺寸规格表

GB Series Rolling Bearings Dimensions Table

订购编码 Order P/N	d mm ²	D mm ²	B mm ²	极限静载荷 Max.static load N	极限动载荷 Max.dynamic load N	极限转速 Max.speed RPM
GB10-6008	40	68	15	290	430	675
GB10-6208	40	80	18	365	550	560
GB10-6308	40	90	23	455	690	468
GB10-16008	40	68	9	250	375	675
GB10-6009	45	75	16	315	465	585
GB10-6209	45	85	19	390	600	522
GB10-6309	45	100	25	450	750	450
GB10-16009	45	75	10	275	415	585
GB10-6010	50	80	16	325	480	540
GB10-6210	50	90	20	450	640	495
GB10-6011	55	90	18	335	500	495
GB10-6211	55	100	21	500	665	450
GB10-6012	60	95	18	350	530	450
GB10-6212	60	110	22	525	730	405
GB10-6013	65	100	18	365	555	430
GB10-6014	70	110	20	380	590	405

GB20 非金属滚动轴承 Nonmetallic Rolling Bearings

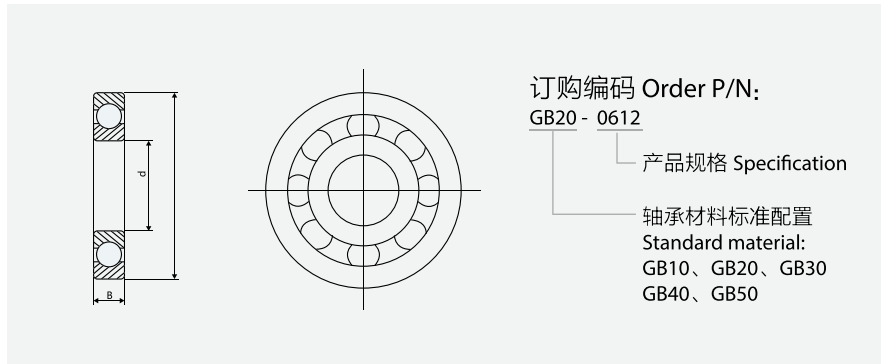

订购编码 Order P/N	d mm ²	D mm ²	B mm ²	极限静载荷 Max.static load N	极限动载荷 Max.dynamic load N	极限转速 Max.speed RPM
GB20-623	3	10	4	25	40	4050
GB20-624	4	13	5	35	50	3240
GB20-625	5	16	5	40	55	2745
GB20-626	6	-	6	40	60	2340
GB20-607	7	19	6	35	50	2340
GB20-627	7	22	7	45	65	1980
GB20-608	8	22	7	45	65	1980
GB20-609	9	24	7	50	75	1845
GB20-629	9	26	8	60	85	1710
GB20-6000	10	26	8	75	110	1710
GB20-6200	10	30	9	110	140	1485
GB20-6300	10	35	11	160	235	1260
GB20-6001	12	28	8	90	135	1575
GB20-6201	12	32	10	125	180	1395
GB20-6301	12	37	12	175	260	1170
GB20-6002	15	32	9	110	160	1395
GB20-6202	15	35	11	140	210	1260

GB 系列滚动轴承尺寸规格表

GB Series Rolling Bearings Dimensions Table

订购编码 Order P/N	d mm ²	D mm ²	B mm ²	极限静载荷 Max.static load N	极限动载荷 Max.dynamic load N	极限转速 Max.speed RPM
GB20-6302	15	42	13	215	310	1080
GB20-16002	15	32	8	110	160	1350
GB20-6003	17	35	10	140	200	1260
GB20-6203	17	40	12	180	265	1125
GB20-6303	17	47	14	250	375	945
GB20-16003	17	35	8	135	200	1260
GB20-6004	20	42	12	165	250	1080
GB20-6204	20	47	14	225	350	945
GB20-6304	20	52	15	290	440	855
GB20-16004	20	42	8	160	240	1035
GB20-6005	25	47	12	200	300	945
GB20-6205	25	52	15	265	400	855
GB20-6305	25	62	17	330	500	655
GB20-16005	25	47	8	175	260	945
GB20-6006	30	55	13	235	350	810
GB20-6206	30	62	16	300	450	720
GB20-6306	30	72	19	380	580	610
GB20-16006	30	55	9	200	310	810
GB20-6007	35	62	14	265	400	720
GB20-6207	35	72	17	340	515	630
GB20-6307	35	80	21	405	625	540
GB20-16007	35	62	9	240	350	720
GB20-6008	40	68	15	290	430	675
GB20-6208	40	80	18	365	550	560
GB20-6308	40	90	23	455	690	468
GB20-16008	40	68	9	250	375	675
GB20-6009	45	75	16	315	465	585
GB20-6209	45	85	19	390	600	522
GB20-6309	45	100	25	450	750	450
GB20-16009	45	75	10	275	415	585
GB20-6010	50	80	16	325	480	540
GB20-6210	50	90	20	450	640	495
GB20-6011	55	90	18	335	500	495
GB20-6211	55	100	21	500	665	450
GB20-6012	60	95	18	350	530	450
GB20-6212	60	110	22	525	730	405
GB20-6013	65	100	18	365	555	430
GB20-6014	70	110	20	380	590	405

GB30 非金属滚动轴承 Nonmetallic Rolling Bearings

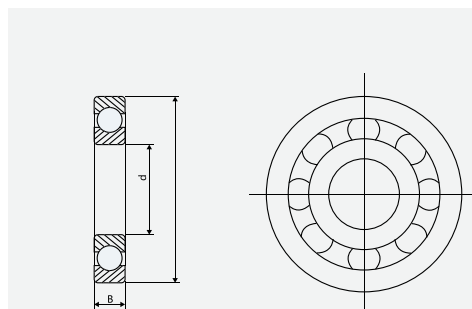
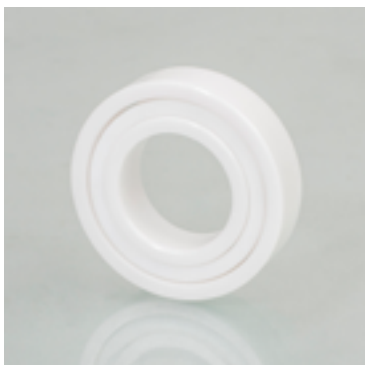

订购编码 Order P/N:

GB30 - 0612

产品规格 Specification

轴承材料标准配置
Standard material:
GB10、GB20、GB30
GB40、GB50

GB 系列滚动轴承尺寸规格表

GB Series Rolling Bearings Dimensions Table

订购编码 Order P/N	d mm ²	D mm ²	B mm ²	极限静载荷 Max.static load N	极限动载荷 Max.dynamic load N	极限转速 Max.speed RPM
GB30-623	3	10	4	25	40	4050
GB30-624	4	13	5	35	50	3240
GB30-625	5	16	5	40	55	2745
GB30-626	6	-	6	40	60	2340
GB30-607	7	19	6	35	50	2340
GB30-627	7	22	7	45	65	1980
GB30-608	8	22	7	45	65	1980
GB30-609	9	24	7	50	75	1845
GB30-629	9	26	8	60	85	1710
GB30-6000	10	26	8	75	110	1710
GB30-6200	10	30	9	110	140	1485
GB30-6300	10	35	11	160	235	1260
GB30-6001	12	28	8	90	135	1575
GB30-6201	12	32	10	125	180	1395
GB30-6301	12	37	12	175	260	1170
GB30-6002	15	32	9	110	160	1395
GB30-6202	15	35	11	140	210	1260
GB30-6302	15	42	13	215	310	1080
GB30-16002	15	32	8	110	160	1350
GB30-6003	17	35	10	140	200	1260
GB30-6203	17	40	12	180	265	1125
GB30-6303	17	47	14	250	375	945
GB30-16003	17	35	8	135	200	1260
GB30-6004	20	42	12	165	250	1080
GB30-6204	20	47	14	225	350	945
GB30-6304	20	52	15	290	440	855
GB30-16004	20	42	8	160	240	1035
GB30-6005	25	47	12	200	300	945
GB30-6205	25	52	15	265	400	855
GB30-6305	25	62	17	330	500	655
GB30-16005	25	47	8	175	260	945
GB30-6006	30	55	13	235	350	810
GB30-6206	30	62	16	300	450	720
GB30-6306	30	72	19	380	580	610
GB30-16006	30	55	9	200	310	810
GB30-6007	35	62	14	265	400	720
GB30-6207	35	72	17	340	515	630
GB30-6307	35	80	21	405	625	540
GB30-16007	35	62	9	240	350	720
GB30-6008	40	68	15	290	430	675
GB30-6208	40	80	18	365	550	560
GB30-6308	40	90	23	455	690	468
GB30-16008	40	68	9	250	375	675
GB30-6009	45	75	16	315	465	585
GB30-6209	45	85	19	390	600	522
GB30-6309	45	100	25	450	750	450
GB30-16009	45	75	10	275	415	585
GB30-6010	50	80	16	325	480	540
GB30-6210	50	90	20	450	640	495
GB30-6011	55	90	18	335	500	495
GB30-6211	55	100	21	500	665	450
GB30-6012	60	95	18	350	530	450
GB30-6212	60	110	22	525	730	405
GB30-6013	65	100	18	365	555	430
GB30-6014	70	110	20	380	590	405

GB 系列滚动轴承尺寸规格表

GB Series Rolling Bearings Dimensions Table

GB40 非金属滚动轴承 Nonmetallic Rolling Bearings

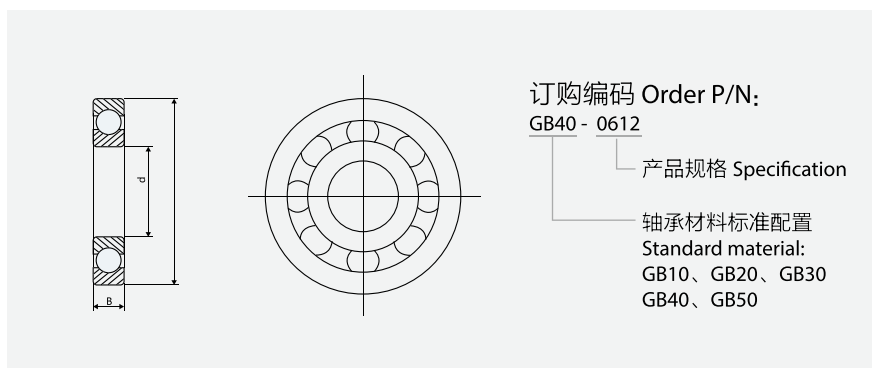

订购编码 Order P/N	d mm ²	D mm ²	B mm ²	极限静载荷 Max.static load N	极限动载荷 Max.dynamic load N	极限转速 Max.speed RPM
GB40-623	3	10	4	25	40	4050
GB40-624	4	13	5	35	50	3240
GB40-625	5	16	5	40	55	2745
GB40-626	6	-	6	40	60	2340
GB40-607	7	19	6	35	50	2340
GB40-627	7	22	7	45	65	1980
GB40-608	8	22	7	45	65	1980
GB40-609	9	24	7	50	75	1845
GB40-629	9	26	8	60	85	1710
GB40-6000	10	26	8	75	110	1710
GB40-6200	10	30	9	110	140	1485
GB40-6300	10	35	11	160	235	1260
GB40-6001	12	28	8	90	135	1575
GB40-6201	12	32	10	125	180	1395
GB40-6301	12	37	12	175	260	1170
GB40-6002	15	32	9	110	160	1395
GB40-6202	15	35	11	140	210	1260
GB40-6302	15	42	13	215	310	1080
GB40-16002	15	32	8	110	160	1350
GB40-6003	17	35	10	140	200	1260
GB40-6203	17	40	12	180	265	1125
GB40-6303	17	47	14	250	375	945
GB40-16003	17	35	8	135	200	1260
GB40-6004	20	42	12	165	250	1080
GB40-6204	20	47	14	225	350	945
GB40-6304	20	52	15	290	440	855
GB40-16004	20	42	8	160	240	1035
GB40-6005	25	47	12	200	300	945
GB40-6205	25	52	15	265	400	855
GB40-6305	25	62	17	330	500	655
GB40-16005	25	47	8	175	260	945
GB40-6006	30	55	13	235	350	810
GB40-6206	30	62	16	300	450	720
GB40-6306	30	72	19	380	580	610
GB40-16006	30	55	9	200	310	810
GB40-6007	35	62	14	265	400	720
GB40-6207	35	72	17	340	515	630
GB40-6307	35	80	21	405	625	540
GB40-16007	35	62	9	240	350	720

GB 系列滚动轴承尺寸规格表

GB Series Rolling Bearings Dimensions Table

订购编码 Order P/N	d mm ²	D mm ²	B mm ²	极限静载荷 Max.static load N	极限动载荷 Max.dynamic load N	极限转速 Max.speed RPM
GB40-6008	40	68	15	290	430	675
GB40-6208	40	80	18	365	550	560
GB40-6308	40	90	23	455	690	468
GB40-16008	40	68	9	250	375	675
GB40-6009	45	75	16	315	465	585
GB40-6209	45	85	19	390	600	522
GB40-6309	45	100	25	450	750	450
GB40-16009	45	75	10	275	415	585
GB40-6010	50	80	16	325	480	540
GB40-6210	50	90	20	450	640	495
GB40-6011	55	90	18	335	500	495
GB40-6211	55	100	21	500	665	450
GB40-6012	60	95	18	350	530	450
GB40-6212	60	110	22	525	730	405
GB40-6013	65	100	18	365	555	430
GB40-6014	70	110	20	380	590	405

GB50 陶瓷滚动轴承 Ceramic Rolling Bearings

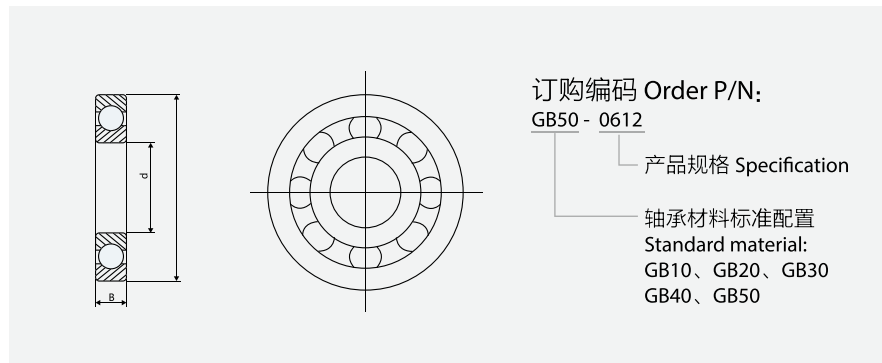
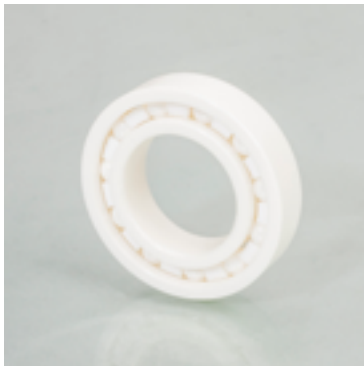

订购编码 Order P/N	d mm ²	D mm ²	B mm ²	极限静载荷 Max.static load N	极限动载荷 Max.dynamic load N	极限转速 Max.speed RPM
GB50-623	3	10	4	25	40	4050
GB50-624	4	13	5	35	50	3240
GB50-625	5	16	5	40	55	2745
GB50-626	6	-	6	40	60	2340
GB50-607	7	19	6	35	50	2340
GB50-627	7	22	7	45	65	1980
GB50-608	8	22	7	45	65	1980
GB50-609	9	24	7	50	75	1845
GB50-629	9	26	8	60	85	1710
GB50-6000	10	26	8	75	110	1710
GB50-6200	10	30	9	110	140	1485
GB50-6300	10	35	11	160	235	1260
GB50-6001	12	28	8	90	135	1575
GB50-6201	12	32	10	125	180	1395
GB50-6301	12	37	12	175	260	1170
GB50-6002	15	32	9	110	160	1395
GB50-6202	15	35	11	140	210	1260

GB 系列滚动轴承尺寸规格表

GB Series Rolling Bearings Dimensions Table

订购编码 Order P/N	d mm ²	D mm ²	B mm ²	极限静载荷 Max.static load N	极限动载荷 Max.dynamic load N	极限转速 Max.speed RPM
GB50-6302	15	42	13	215	310	1080
GB50-16002	15	32	8	110	160	1350
GB50-6003	17	35	10	140	200	1260
GB50-6203	17	40	12	180	265	1125
GB50-6303	17	47	14	250	375	945
GB50-16003	17	35	8	135	200	1260
GB50-6004	20	42	12	165	250	1080
GB50-6204	20	47	14	225	350	945
GB50-6304	20	52	15	290	440	855
GB50-16004	20	42	8	160	240	1035
GB50-6005	25	47	12	200	300	945
GB50-6205	25	52	15	265	400	855
GB50-6305	25	62	17	330	500	655
GB50-16005	25	47	8	175	260	945
GB50-6006	30	55	13	235	350	810
GB50-6206	30	62	16	300	450	720
GB50-6306	30	72	19	380	580	610
GB50-16006	30	55	9	200	310	810
GB50-6007	35	62	14	265	400	720
GB50-6207	35	72	17	340	515	630
GB50-6307	35	80	21	405	625	540
GB50-16007	35	62	9	240	350	720
GB50-6008	40	68	15	290	430	675
GB50-6208	40	80	18	365	550	560
GB50-6308	40	90	23	455	690	468
GB50-16008	40	68	9	250	375	675
GB50-6009	45	75	16	315	465	585
GB50-6209	45	85	19	390	600	522
GB50-6309	45	100	25	450	750	450
GB50-16009	45	75	10	275	415	585
GB50-6010	50	80	16	325	480	540
GB50-6210	50	90	20	450	640	495
GB50-6011	55	90	18	335	500	495
GB50-6211	55	100	21	500	665	450
GB50-6012	60	95	18	350	530	450
GB50-6212	60	110	22	525	730	405
GB50-6013	65	100	18	365	555	430
GB50-6014	70	110	20	380	590	405